

FEATURES

- Linear in dB Gain Control**
- Pin Programmable Gain Ranges**
 - 11 dB to +31 dB with 90 MHz Bandwidth
 - 9 dB to 51 dB with 9 MHz Bandwidth
- Any Intermediate Range, e.g., -1 dB to +41 dB with 30 MHz Bandwidth**
- Bandwidth Independent of Variable Gain**
- 1.3 nV/ $\sqrt{\text{Hz}}$ Input Noise Spectral Density**
- ± 0.5 dB Typical Gain Accuracy**
- MIL-STD-883 Compliant and DESC Versions Available**

APPLICATIONS

- RF/IF AGC Amplifier**
- Video Gain Control**
- A/D Range Extension**
- Signal Measurement**

PRODUCT DESCRIPTION

The AD603 is a low noise, voltage-controlled amplifier for use in RF and IF AGC systems. It provides accurate, pin selectable gains of -11 dB to +31 dB with a bandwidth of 90 MHz or 9 dB to 51 dB with a bandwidth of 9 MHz. Any intermediate gain range may be arranged using one external resistor. The input referred noise spectral density is only 1.3 nV/ $\sqrt{\text{Hz}}$ and power consumption is 125 mW at the recommended ± 5 V supplies.

The decibel gain is linear in dB, accurately calibrated, and stable over temperature and supply. The gain is controlled at a high impedance (50 M Ω), low bias (200 nA) differential input; the

scaling is 25 mV/dB, requiring a gain-control voltage of only 1 V to span the central 40 dB of the gain range. An overrange and underrange of 1 dB is provided whatever the selected range. The gain-control response time is less than 1 μs for a 40 dB change.

The differential gain-control interface allows the use of either differential or single-ended positive or negative control voltages. Several of these amplifiers may be cascaded and their gain-control gains offset to optimize the system S/N ratio.

The AD603 can drive a load impedance as low as 100 Ω with low distortion. For a 500 Ω load in shunt with 5 pF, the total harmonic distortion for a ± 1 V sinusoidal output at 10 MHz is typically -60 dBc. The peak specified output is ± 2.5 V minimum into a 500 Ω load, or ± 1 V into a 100 Ω load.

The AD603 uses a proprietary circuit topology—the X-AMP[®]. The X-AMP comprises a variable attenuator of 0 dB to -42.14 dB followed by a fixed-gain amplifier. Because of the attenuator, the amplifier never has to cope with large inputs and can use negative feedback to define its (fixed) gain and dynamic performance. The attenuator has an input resistance of 100 Ω , laser trimmed to $\pm 3\%$, and comprises a seven-stage R-2R ladder network, resulting in an attenuation between tap points of 6.021 dB. A proprietary interpolation technique provides a continuous gain-control function which is linear in dB.

The AD603A is specified for operation from -40°C to +85°C and is available in both 8-lead SOIC (R) and 8-lead ceramic Cerdip (Q). The AD603S is specified for operation from -55°C to +125°C and is available in an 8-lead ceramic Cerdip (Q). The AD603 is also available under DESC SMD 5962-94572.

FUNCTIONAL BLOCK DIAGRAM

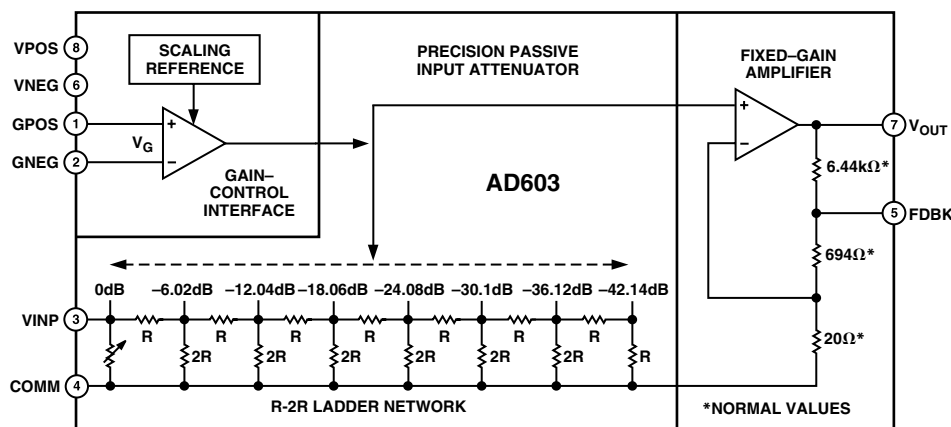

*Patented.

REV. E

Information furnished by Analog Devices is believed to be accurate and reliable. However, no responsibility is assumed by Analog Devices for its use, nor for any infringements of patents or other rights of third parties that may result from its use. No license is granted by implication or otherwise under any patent or patent rights of Analog Devices. Trademarks and registered trademarks are the property of their respective companies.

AD603—SPECIFICATIONS

(@ $T_A = 25^\circ\text{C}$, $V_S = \pm 5\text{ V}$, $-500\text{ mV} \leq V_G \leq +500\text{ mV}$, $\text{GNEG} = 0\text{ V}$, -10 dB to $+30\text{ dB}$ Gain Range, $R_L = 500\ \Omega$, and $C_L = 5\text{ pF}$, unless otherwise noted.)

Model Parameter	Conditions	AD603			Unit
		Min	Typ	Max	
INPUT CHARACTERISTICS					
Input Resistance	Pins 3 to 4	97	100	103	Ω
Input Capacitance			2		pF
Input Noise Spectral Density ¹	Input Short Circuited		1.3		$\text{nV}/\sqrt{\text{Hz}}$
Noise Figure	$f = 10\text{ MHz}$, Gain = max, $R_S = 10\ \Omega$		8.8		dB
1 dB Compression Point	$f = 10\text{ MHz}$, Gain = max, $R_S = 10\ \Omega$		-11		dBm
Peak Input Voltage			± 1.4	± 2	V
OUTPUT CHARACTERISTICS					
-3 dB Bandwidth	$V_{\text{OUT}} = 100\text{ mV rms}$		90		MHz
Slew Rate	$R_L \geq 500\ \Omega$		275		V/ μs
Peak Output ²	$R_L \geq 500\ \Omega$	± 2.5	± 3.0		V
Output Impedance	$f \leq 10\text{ MHz}$		2		Ω
Output Short-Circuit Current			50		mA
Group Delay Change vs. Gain	$f = 3\text{ MHz}$; Full Gain Range		± 2		ns
Group Delay Change vs. Frequency	$V_G = 0\text{ V}$; $f = 1\text{ MHz}$ to 10 MHz		± 2		ns
Differential Gain			0.2		%
Differential Phase			0.2		Degree
Total Harmonic Distortion	$f = 10\text{ MHz}$, $V_{\text{OUT}} = 1\text{ V rms}$		-60		dBc
Third Order Intercept	$f = 40\text{ MHz}$, Gain = max, $R_S = 50\ \Omega$		15		dBm
ACCURACY					
Gain Accuracy	$-500\text{ mV} \leq V_G \leq +500\text{ mV}$	-1	± 0.5	+1	dB
T_{MIN} to T_{MAX}		-1.5		+1.5	dB
Output Offset Voltage ³	$V_G = 0\text{ V}$	-20		+20	mV
T_{MIN} to T_{MAX}		-30		+30	mV
Output Offset Variation vs. V_G	$-500\text{ mV} \leq V_G \leq +500\text{ mV}$	-20		+20	mV
T_{MIN} to T_{MAX}		-30		+30	mV
GAIN CONTROL INTERFACE					
Gain Scaling Factor		39.4	40	40.6	dB/V
T_{MIN} to T_{MAX}		38		42	dB/V
GNEG, GPOS Voltage Range ⁴		-1.2		+2.0	V
Input Bias Current			200		nA
Input Offset Current			10		nA
Differential Input Resistance	Pins 1 to 2		50		M Ω
Response Rate	Full 40 dB Gain Change		40		dB/ μs
POWER SUPPLY					
Specified Operating Range		± 4.75		± 6.3	V
Quiescent Current			12.5	17	mA
T_{MIN} to T_{MAX}				20	mA

NOTES

¹Typical open or short-circuited input; noise is lower when system is set to maximum gain and input is short-circuited. This figure includes the effects of both voltage and current noise sources.

²Using resistive loads of $500\ \Omega$ or greater, or with the addition of a $1\text{ k}\Omega$ pull-down resistor when driving lower loads.

³The dc gain of the main amplifier in the AD603 is $\times 35.7$; thus, an input offset of $100\ \mu\text{V}$ becomes a 3.57 mV output offset.

⁴GNEG and GPOS, gain control, and voltage range are guaranteed to be within the range of $-V_S + 4.2\text{ V}$ to $+V_S - 3.4\text{ V}$ over the full temperature range of -40°C to $+85^\circ\text{C}$.

Specifications shown in **boldface** are tested on all production units at final electrical test. Results from those tests are used to calculate outgoing quality levels. All min and max specifications are guaranteed, although only those shown in **boldface** are tested on all production units.

Specifications subject to change without notice.

ABSOLUTE MAXIMUM RATINGS¹

Supply Voltage $\pm V_S$	± 7.5 V
Internal Voltage VINP (Pin 3)	± 2 V Continuous
.....	$\pm V_S$ for 10 ms
GPOS, GNEG (Pins 1, 2)	$\pm V_S$
Internal Power Dissipation ²	400 mW
Operating Temperature Range	
AD603A	-40°C to $+85^\circ\text{C}$
AD603S	-55°C to $+125^\circ\text{C}$
Storage Temperature Range	-65°C to $+150^\circ\text{C}$
Lead Temperature Range (Soldering 60 sec)	300°C

NOTES

¹Stresses above those listed under Absolute Maximum Ratings may cause permanent damage to the device. This is a stress rating only; functional operation of the device at these or any other conditions above those indicated in the operational section of this specification is not implied. Exposure to absolute maximum rating conditions for extended periods may affect device reliability.

²Thermal Characteristics:

8-Lead SOIC Package: $\theta_{JA} = 155^\circ\text{C}/\text{W}$, $\theta_{JC} = 33^\circ\text{C}/\text{W}$

8-Lead CERDIP Package: $\theta_{JA} = 140^\circ\text{C}/\text{W}$, $\theta_{JC} = 15^\circ\text{C}/\text{W}$

PIN FUNCTION DESCRIPTIONS

Pin No.	Mnemonic	Description
1	GPOS	Gain-Control Input High (Positive Voltage Increases Gain)
2	GNEG	Gain-Control Input Low (Negative Voltage Increases Gain)
3	VINP	Amplifier Input
4	COMM	Amplifier Ground
5	FDBK	Connection to Feedback Network
6	VNEG	Negative Supply Input
7	VOUT	Amplifier Output
8	VPOS	Positive Supply Input

CONNECTION DIAGRAM

8-Lead Plastic SOIC (R) Package
8-Lead Ceramic CERDIP (Q) Package

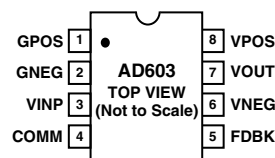

ORDERING GUIDE

Part Number	Temperature Range	Package Description	Package Option
AD603AR	-40°C to $+85^\circ\text{C}$	8-Lead SOIC	R-8
AD603AQ	-40°C to $+85^\circ\text{C}$	8-Lead CERDIP	Q-8
AD603SQ/883B*	-55°C to $+125^\circ\text{C}$	8-Lead CERDIP	Q-8
AD603-EB		Evaluation Board	
AD603ACHIPS	-40°C to $+85^\circ\text{C}$	Die	
AD603AR-REEL	-40°C to $+85^\circ\text{C}$	13" Reel	R-8
AD603AR-REEL7	-40°C to $+85^\circ\text{C}$	7" Reel	R-8

*Refer to AD603 Military data sheet. Also available as 5962-9457203MPA.

CAUTION

ESD (electrostatic discharge) sensitive device. Electrostatic charges as high as 4000 V readily accumulate on the human body and test equipment and can discharge without detection. Although the AD603 features proprietary ESD protection circuitry, permanent damage may occur on devices subjected to high energy electrostatic discharges. Therefore, proper ESD precautions are recommended to avoid performance degradation or loss of functionality.



AD603—Typical Performance Characteristics

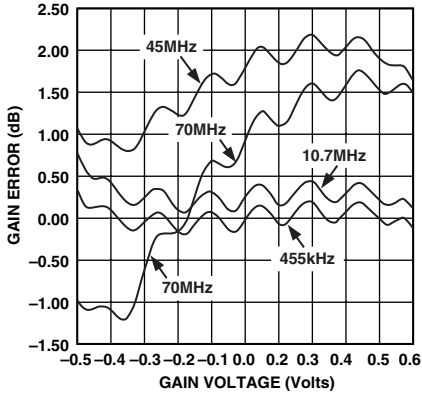

TPC 1. Gain Error vs. Gain Control Voltage at 455 kHz, 10.7 MHz, 45 MHz, 70 MHz

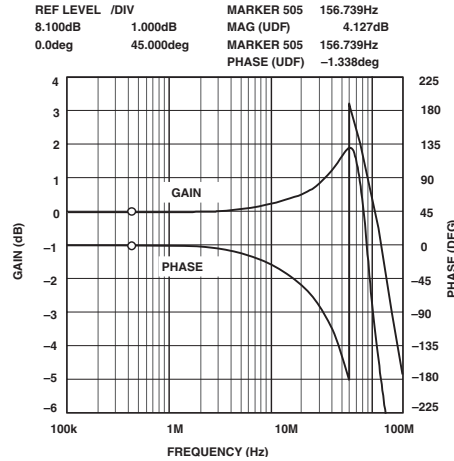

TPC 2. Frequency and Phase Response vs. Gain (Gain = -10 dB, $P_{IN} = -30$ dBm, Pin 5 Connected to Pin 7)

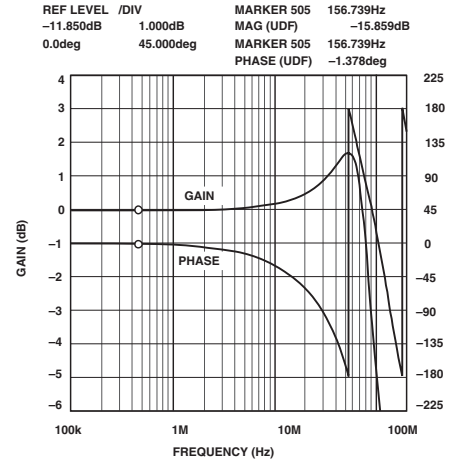

TPC 3. Frequency and Phase Response vs. Gain (Gain = +10 dB, $P_{IN} = -30$ dBm, Pin 5 Connected to Pin 7)

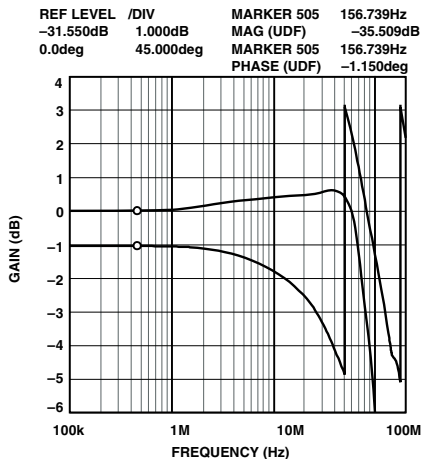

TPC 4. Frequency and Phase Response vs. Gain (Gain = +30 dB, $P_{IN} = -30$ dBm, Pin 5 Connected to Pin 7)

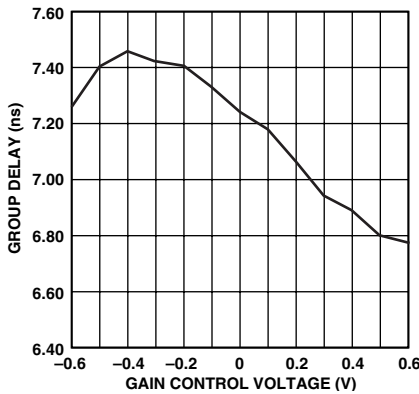

TPC 5. Group Delay vs. Gain Control Voltage

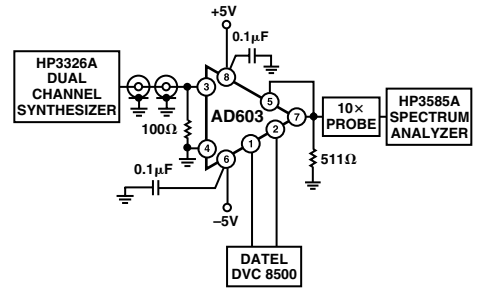

TPC 6. Third Order Intermodulation Distortion Test Setup

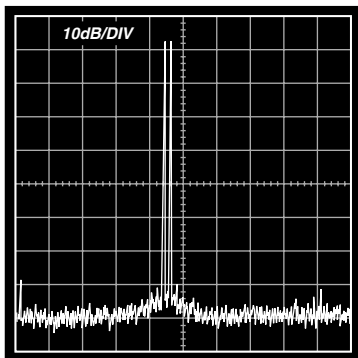

TPC 7. Third Order Intermodulation Distortion at 455 kHz (10× Probe Used to HP3585A Spectrum Analyzer, Gain = 0 dB, $P_{IN} = 0$ dBm, Pin 5 Connected to Pin 7)

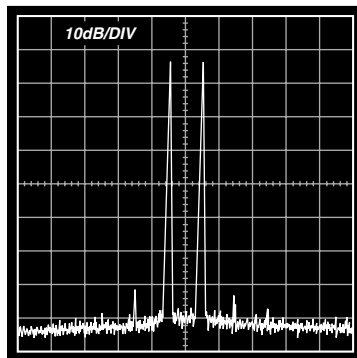

TPC 8. Third Order Intermodulation Distortion at 10.7 MHz (10× Probe Used to HP3585A Spectrum Analyzer, Gain = 0 dB, $P_{IN} = 0$ dBm, Pin 5 Connected to Pin 7)

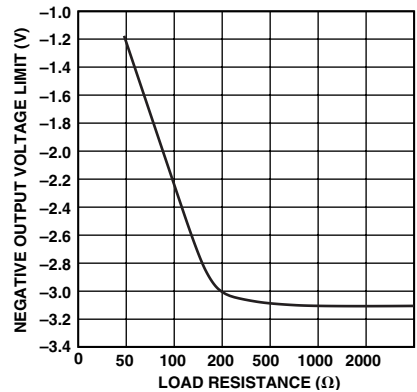

TPC 9. Typical Output Voltage Swing vs. Load Resistance (Negative Output Swing Limits First)

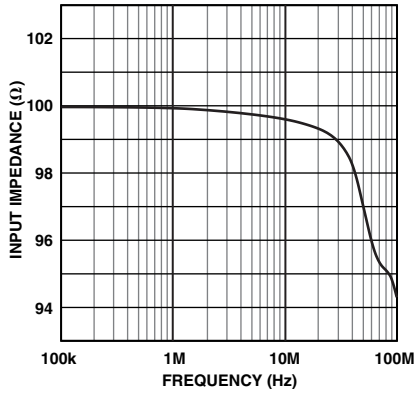

TPC 10. Input Impedance vs. Frequency (Gain = -10 dB)

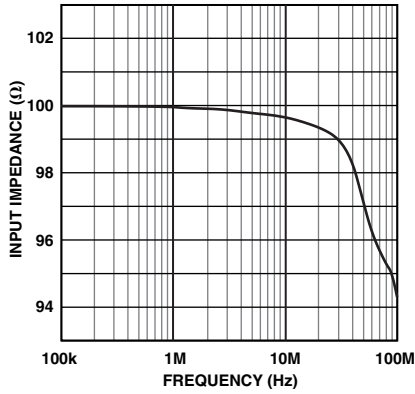

TPC 11. Input Impedance vs. Frequency (Gain = +10 dB)

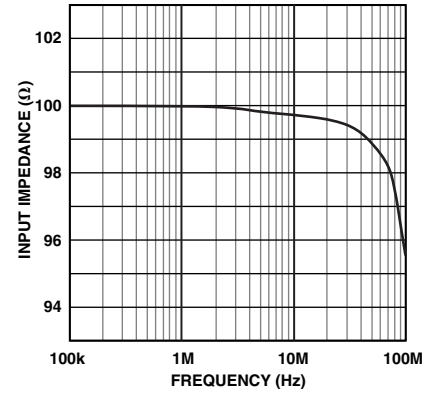

TPC 12. Input Impedance vs. Frequency (Gain = +30 dB)

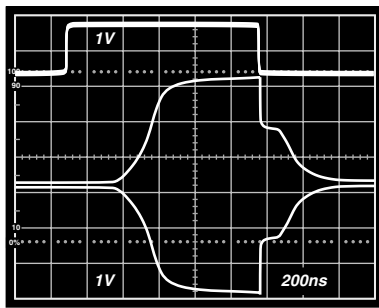

TPC 13. Gain-Control Channel Response Time

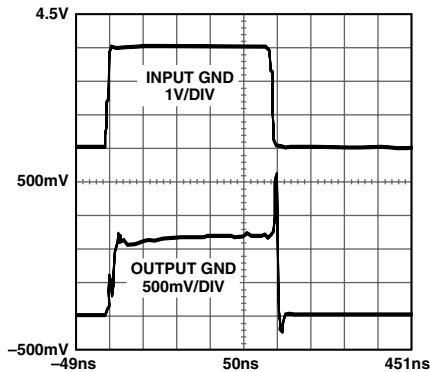

TPC 14. Input Stage Overload Recovery Time, Pin 5 Connected to Pin 7 (Input Is 500 ns Period, 50% Duty-Cycle Square Wave, Output Is Captured Using Tektronix 11402 Digitizing Oscilloscope)

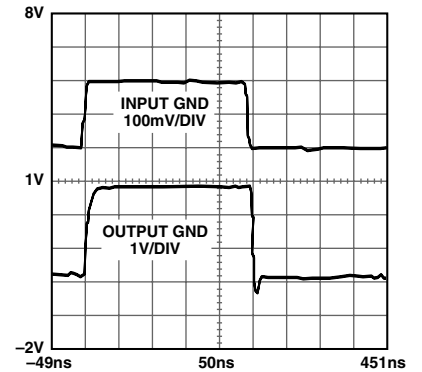

TPC 15. Output Stage Overload Recovery Time, Pin 5 Connected to Pin 7 (Input Is 500 ns Period, 50% Duty-Cycle Square Wave, Output Is Captured Using Tektronix 11402 Digitizing Oscilloscope)

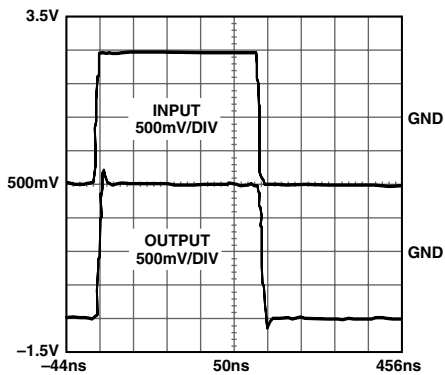

TPC 16. Transient Response, $G = 0$ dB, Pin 5 Connected to Pin 7 (Input Is 500 ns Period, 50% Duty-Cycle Square Wave, Output Is Captured Using Tektronix 11402 Digitizing Oscilloscope)

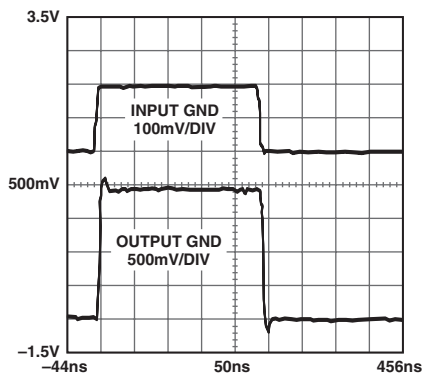

TPC 17. Transient Response, $G = +20$ dB, Pin 5 Connected to Pin 7 (Input Is 500 ns Period, 50% Duty-Cycle Square Wave, Output Is Captured Using Tektronix 11402 Digitizing Oscilloscope)

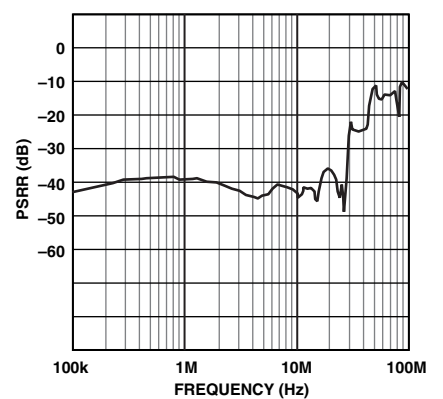

TPC 18. PSRR vs. Frequency (Worst Case Is Negative Supply PSRR, Shown Here)

AD603

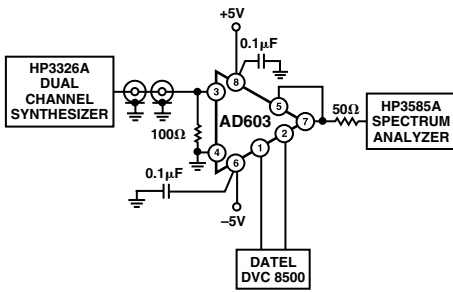

TPC 19. Test Setup Used for: Noise Figure, Third Order Intercept and 1 dB Compression Point Measurements

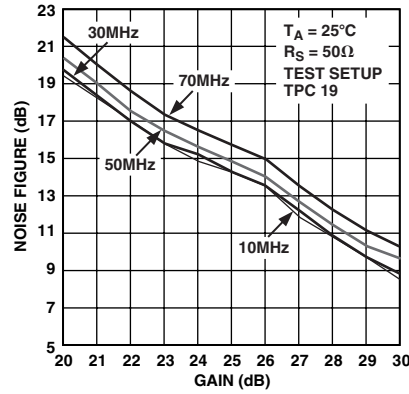

TPC 20. Noise Figure in -10 dB/+30 dB Mode

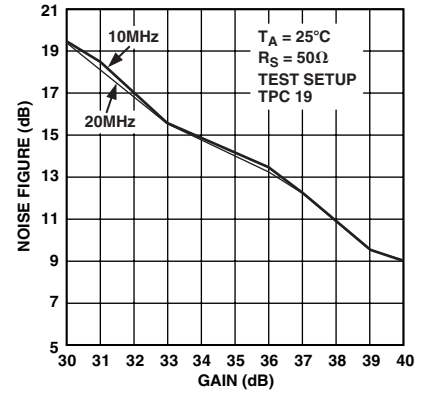

TPC 21. Noise Figure in 0 dB/40 dB Mode

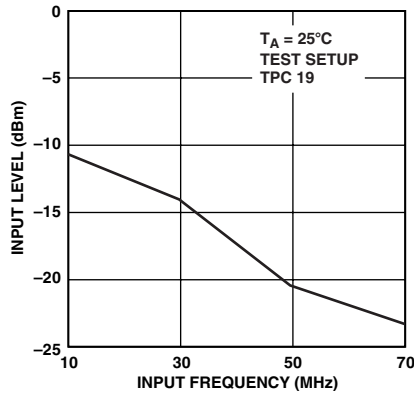

TPC 22. 1 dB Compression Point, -10 dB/+30 dB Mode, Gain = +30 dB

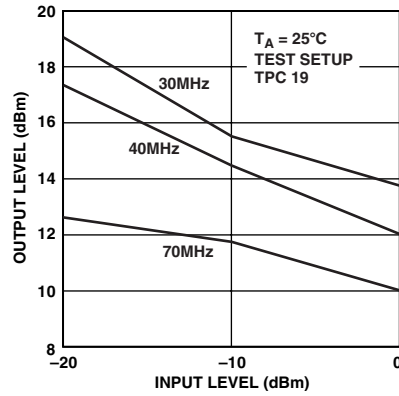

TPC 23. Third Order Intercept -10 dB/+30 dB Mode, Gain = +10 dB

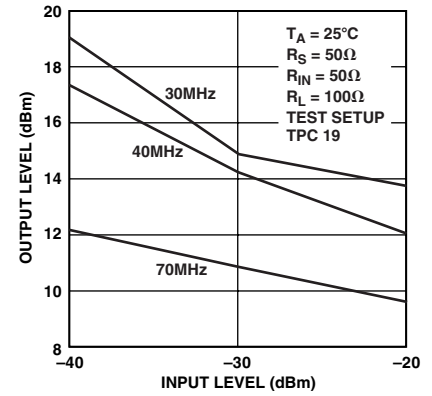

TPC 24. Third Order Intercept, -10 dB/+30 dB Mode, Gain = +30 dB

THEORY OF OPERATION

The AD603 comprises a fixed-gain amplifier, preceded by a broadband passive attenuator of 0 dB to 42.14 dB, having a gain-control scaling factor of 40 dB per volt. The fixed gain is laser-trimmed in two ranges, to either 31.07 dB ($\times 35.8$) or 50 dB ($\times 358$), or may be set to any range in between using one external resistor between Pins 5 and 7. Somewhat higher gain can be obtained by connecting the resistor from Pin 5 to common, but the increase in output offset voltage limits the maximum gain to about 60 dB. For any given range, the bandwidth is independent of the voltage-controlled gain. This system provides an underrange and overrange of 1.07 dB in all cases; for example, the overall gain is -11.07 dB to $+31.07$ dB in the maximum-bandwidth mode (Pin 5 and Pin 7 strapped).

This X-AMP structure has many advantages over former methods of gain-control based on nonlinear elements. Most importantly, the fixed-gain amplifier can use negative feedback to increase its accuracy. Since large inputs are first attenuated, the amplifier input is always small. For example, to deliver a ± 1 V output in the -1 dB/ $+41$ dB mode (that is, using a fixed amplifier gain of 41.07 dB) its input is only 8.84 mV; thus the distortion can be very low. Equally important, the small-signal gain and phase response, and thus the pulse response, are essentially independent of gain.

Figure 1 is a simplified schematic. The input attenuator is a seven-section R-2R ladder network, using untrimmed resistors of nominally $R = 62.5 \Omega$, which results in a characteristic resistance of $125 \Omega \pm 20\%$. A shunt resistor is included at the input and laser trimmed to establish a more exact input resistance of $100 \Omega \pm 3\%$, which ensures accurate operation (gain and HP corner frequency) when used in conjunction with external resistors or capacitors.

The nominal maximum signal at input VINP is 1 V rms (± 1.4 V peak) when using the recommended ± 5 V supplies, although operation to ± 2 V peak is permissible with some increase in HF distortion and feedthrough. Pin 4 (SIGNAL COMMON) must be connected directly to the input ground; significant impedance in this connection will reduce the gain accuracy.

The signal applied at the input of the ladder network is attenuated by 6.02 dB by each section; thus, the attenuation to each of the taps is progressively 0 dB, 6.02 dB, 12.04 dB, 18.06 dB, 24.08 dB, 30.1 dB, 36.12 dB, and 42.14 dB. A unique circuit

technique is employed to interpolate between these tap points, indicated by the slider in Figure 1, thus providing continuous attenuation from 0 dB to 42.14 dB. It will help in understanding the AD603 to think in terms of a mechanical means for moving this slider from left to right; in fact, its position is controlled by the voltage between Pins 1 and 2. The details of the gain-control interface are discussed later.

The gain is at all times very exactly determined, and a linear-in-dB relationship is automatically guaranteed by the exponential nature of the attenuation in the ladder network (the X-AMP principle). In practice, the gain deviates slightly from the ideal law, by about ± 0.2 dB peak (see, for example, TPC 1).

Noise Performance

An important advantage of the X-AMP is its superior noise performance. The nominal resistance seen at inner tap points is 41.7Ω (one third of 125Ω), which exhibits a Johnson noise-spectral density (NSD) of $0.83 \text{ nV}/\sqrt{\text{Hz}}$ (that is, $\sqrt{4kTR}$) at 27°C , which is a large fraction of the total input noise. The first stage of the amplifier contributes a further $1 \text{ nV}/\sqrt{\text{Hz}}$, for a total input noise of $1.3 \text{ nV}/\sqrt{\text{Hz}}$. It will be apparent that it is essential to use a low resistance in the ladder network to achieve the very low specified noise level. The signal's source impedance forms a voltage divider with the AD603's 100Ω input resistance. In some applications, the resulting attenuation may be unacceptable, requiring the use of an external buffer or preamplifier to match a high impedance source to the low impedance AD603.

The noise at maximum gain (that is, at the 0 dB tap) depends on whether the input is short-circuited or open-circuited: when shorted, the minimum NSD of slightly over $1 \text{ nV}/\sqrt{\text{Hz}}$ is achieved; when open, the resistance of 100Ω looking into the first tap generates $1.29 \text{ nV}/\sqrt{\text{Hz}}$, so the noise increases to a total of $1.63 \text{ nV}/\sqrt{\text{Hz}}$. (This last calculation would be important if the AD603 were preceded by, for example, a 900Ω resistor to allow operation from inputs up to 10 V rms.) As the selected tap moves away from the input, the dependence of the noise on source impedance quickly diminishes.

Apart from the small variations just discussed, the signal-to-noise (S/N) ratio at the output is essentially independent of the attenuator setting. For example, on the -11 dB/ $+31$ dB range, the fixed gain of $\times 35.8$ raises the output NSD to $46.5 \text{ nV}/\sqrt{\text{Hz}}$. Thus, for the maximum undistorted output of 1 V rms and a 1 MHz bandwidth, the output S/N ratio would be 86.6 dB, that is, 20 log (1 V/ $46.5 \mu\text{V}$).

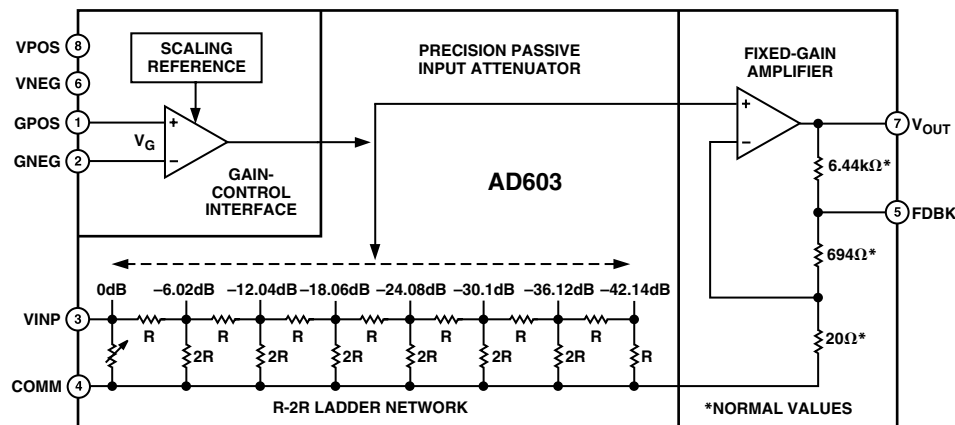

Figure 1. Simplified Block Diagram

AD603

The Gain-Control Interface

The attenuation is controlled through a differential, high impedance (50 MΩ) input, with a scaling factor which is laser-trimmed to 40 dB per volt, that is, 25 mV/dB. An internal band gap reference ensures stability of the scaling with respect to supply and temperature variations.

When the differential input voltage $V_G = 0$ V, the attenuator slider is centered, providing an attenuation of 21.07 dB. For the maximum bandwidth range, this results in an overall gain of 10 dB (= -21.07 dB + 31.07 dB). When the control input is -500 mV, the gain is lowered by 20 dB (= 0.500 V × 40 dB/V), to -10 dB; when set to +500 mV, the gain is increased by 20 dB, to 30 dB. When this interface is overdriven in either direction, the gain approaches either -11.07 dB (= -42.14 dB + 31.07 dB) or 31.07 dB (= 0 + 31.07 dB), respectively. The only constraint on the gain-control voltage is that it be kept within the common-mode range (-1.2 V to +2.0 V assuming +5 V supplies) of the gain control interface.

The basic gain of the AD603 can thus be calculated using the following simple expression:

$$\text{Gain (dB)} = 40 V_G + 10 \quad (1)$$

where V_G is in volts. When Pins 5 and 7 are strapped (see next section), the gain becomes

$$\text{Gain (dB)} = 40 V_G + 20 \text{ for } 0 \text{ to } +40 \text{ dB}$$

and

$$\text{Gain (dB)} = 40 V_G + 30 \text{ for } +10 \text{ to } +50 \text{ dB} \quad (2)$$

The high impedance gain-control input ensures minimal loading when driving many amplifiers in multiple channel or cascaded applications. The differential capability provides flexibility in choosing the appropriate signal levels and polarities for various control schemes.

For example, if the gain is to be controlled by a DAC providing a positive only ground-referenced output, the Gain Control Low (GNEG) pin should be biased to a fixed offset of 500 mV, to set the gain to -10 dB when Gain Control High (GPOS) is at zero, and to 30 dB when at 1.00 V.

It is a simple matter to include a voltage divider to achieve other scaling factors. When using an 8-bit DAC having an FS output of 2.55 V (10 mV/bit), a divider ratio of 2 (generating 5 mV/bit) would result in a gain-setting resolution of 0.2 dB/bit. The use of such offsets is valuable when two AD603s are cascaded, when various options exist for optimizing the S/N profile, as will be shown later.

Programming the Fixed-Gain Amplifier Using Pin Strapping

Access to the feedback network is provided at Pin 5 (FDBK). The user may program the gain of the AD603's output amplifier using this pin, as shown in Figure 2. There are three modes: in the default mode, FDBK is unconnected, providing the range +9 dB/+51 dB; when V_{OUT} and FDBK are shorted, the gain is lowered to -11 dB/+31 dB; when an external resistor is placed between V_{OUT} and FDBK any intermediate gain can be achieved, for example, -1 dB/+41 dB. Figure 3 shows the nominal maximum gain versus external resistor for this mode.

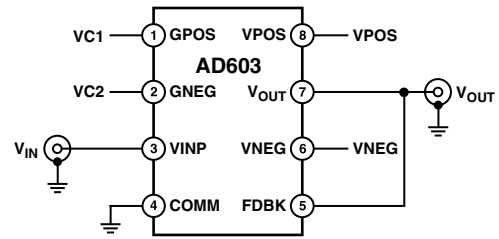

a. -10 dB to +30 dB; 90 MHz Bandwidth

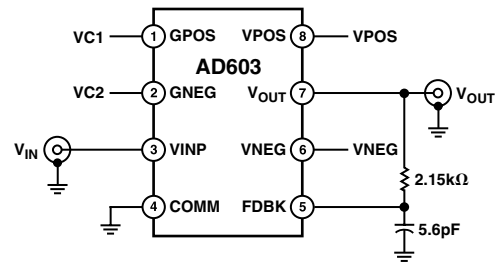

b. 0 dB to 40 dB; 30 MHz Bandwidth

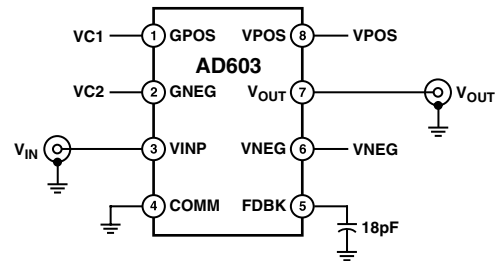

c. 10 dB to 50 dB; 9 MHz Bandwidth

Figure 2. Pin Strapping to Set Gain

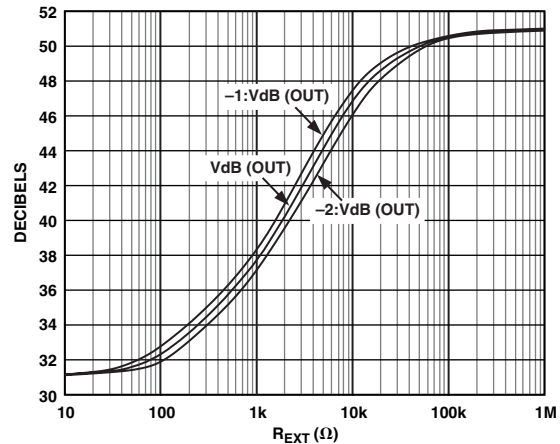

Figure 3. Gain vs. R_{EXT} , Showing Worst-Case Limits Assuming Internal Resistors Have a Maximum Tolerance of 20%

Optionally, when a resistor is placed from FDBK to COMM, higher gains can be achieved. This fourth mode is of limited value because of the low bandwidth and the elevated output offsets; it is thus not included in Figure 2.

The gain of this amplifier in the first two modes is set by the ratio of on-chip laser-trimmed resistors. While the ratio of these resistors is very accurate, the absolute value of these resistors can vary by as much as $\pm 20\%$. Thus, when an external resistor is connected in parallel with the nominal $6.44 \text{ k}\Omega \pm 20\%$ internal resistor, the overall gain accuracy is somewhat poorer. The worst-case error occurs at about $2 \text{ k}\Omega$ (see Figure 4).

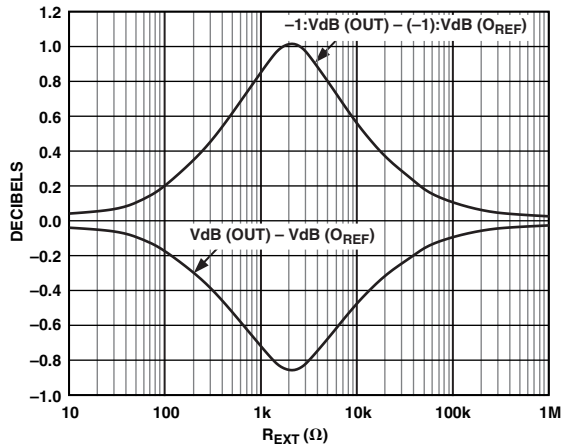

Figure 4. Worst-Case Gain Error, Assuming Internal Resistors Have a Maximum Tolerance of -20% (Top Curve) or $+20\%$ (Bottom Curve)

While the gain-bandwidth product of the fixed-gain amplifier is about 4 GHz , the actual bandwidth is not exactly related to the maximum gain. This is because there is a slight enhancing of the ac response magnitude on the maximum bandwidth range, due to higher order poles in the open-loop gain function; this mild peaking is not present on the higher gain ranges. Figure 2 shows how optional capacitors may be added to extend the frequency response in high gain modes.

CASCADING TWO AD603S

Two or more AD603s can be connected in series to achieve higher gain. Invariably, ac coupling must be used to prevent the dc offset voltage at the output of each amplifier from overloading the following amplifier at maximum gain. The required high-pass coupling network will usually be just a capacitor, chosen to set the desired corner frequency in conjunction with the well defined 100Ω input resistance of the following amplifier.

For two AD603s, the total gain-control range becomes 84 dB ($2 \times 42.14 \text{ dB}$); the overall -3 dB bandwidth of cascaded stages will be somewhat reduced. Depending on the pin strapping, the gain and bandwidth for two cascaded amplifiers can range from -22 dB to $+62 \text{ dB}$ (with a bandwidth of about 70 MHz) to $+22 \text{ dB}$ to $+102 \text{ dB}$ (with a bandwidth of about 6 MHz).

There are several ways of connecting the gain-control inputs in cascaded operation. The choice depends on whether it is important to achieve the highest possible Instantaneous Signal-to-Noise Ratio (ISNR), or, alternatively, to minimize the ripple in the gain error. The following examples feature the AD603 programmed for maximum bandwidth; the explanations apply to other gain/bandwidth combinations with appropriate changes to the arrangements for setting the maximum gain.

Sequential Mode (Optimal S/N Ratio)

In the sequential mode of operation, the ISNR is maintained at its highest level for as much of the gain control range possible. Figure 5 shows the SNR over a gain range of -22 dB to $+62 \text{ dB}$, assuming an output of 1 V rms and a 1 MHz bandwidth; Figure 6 shows the general connections to accomplish this. Here, both the positive gain-control inputs (GPOS) are driven in parallel by a positive-only, ground-referenced source with a range of 0 V to $+2 \text{ V}$, while the negative gain-control inputs (GNEG) are biased by stable voltages to provide the needed gain offsets. These voltages may be provided by resistive dividers operating from a common voltage reference.

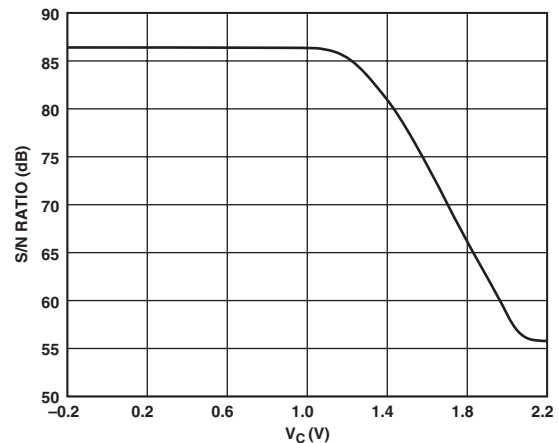

Figure 5. SNR vs. Control Voltage—Sequential Control (1 MHz Bandwidth)

The gains are offset (Figure 7) such that A2's gain is increased only after A1's gain has reached its maximum value. Note that for a differential input of -600 mV or less, the gain of a single amplifier (A1 or A2) will be at its minimum value of -11.07 dB ; for a differential input of $+600 \text{ mV}$ or more, the gain will be at its maximum value of 31.07 dB . Control inputs beyond these limits will not affect the gain and can be tolerated without damage or foldover in the response. This is an important aspect of the AD603's gain-control response. (See the Specifications section of this data sheet for more details on the allowable voltage range.) The gain is now

$$\text{Gain (dB)} = 40 V_G + G_O \quad (3)$$

where V_G is the applied control voltage and G_O is determined by the gain range chosen. In the explanatory notes that follow, we assume the maximum bandwidth connections are used, for which G_O is -20 dB .

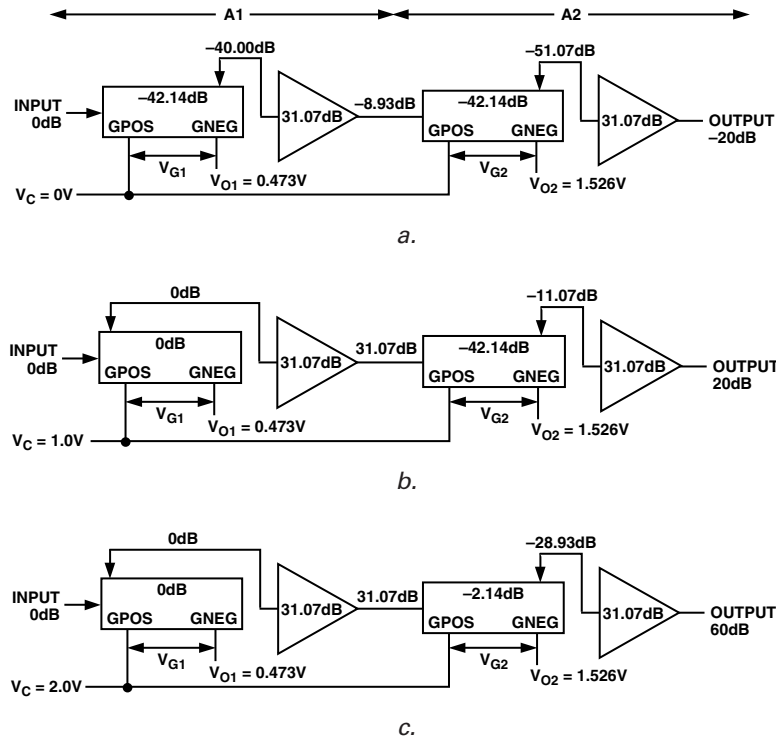

Figure 6. AD603 Gain Control Input Calculations for Sequential Control Operation

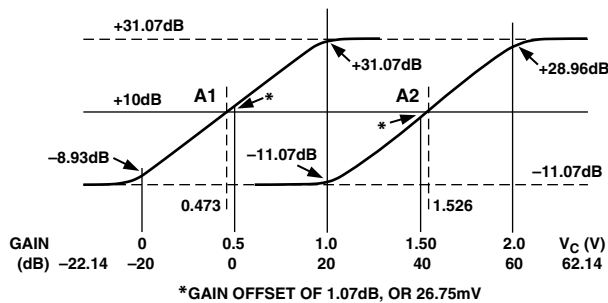

Figure 7. Explanation of Offset Calibration for Sequential Control

With reference to Figure 6, note that V_{G1} refers to the differential gain-control input to A1, and V_{G2} refers to the differential gain-control input to A2. When V_G is 0, $V_{G1} = -473$ mV and thus the gain of A1 is -8.93 dB (recall that the gain of each individual amplifier in the maximum bandwidth mode is -10 dB for $V_G = -500$ mV and 10 dB for $V_G = 0$ V); meanwhile, $V_{G2} = -1.908$ V so the gain of A2 is pinned at -11.07 dB. The overall gain is thus -20 dB. This situation is shown in Figure 6a.

When $V_G = +1.00$ V, $V_{G1} = 1.00$ V $- 0.473$ V = $+0.526$ V, which sets the gain of A1 to at nearly its maximum value of 31.07 dB, while $V_{G2} = 1.00$ V $- 1.526$ V = 0.526 V, which sets A2's gain at nearly its minimum value -11.07 dB. Close analysis shows that the degree to which neither AD603 is completely pushed to its maximum or minimum gain exactly cancels in the overall gain, which is now $+20$ dB. This is depicted in Figure 6b.

When $V_G = 2.0$ V, the gain of A1 is pinned at 31.07 dB and that of A2 is near its maximum value of 28.93 dB, resulting in an overall gain of 60 dB (see Figure 6c). This mode of operation is further clarified by Figure 8, which is a plot of the separate gains of A1 and A2 and the overall gain versus the control voltage. Figure 9 is a plot of the SNR of the cascaded amplifiers versus the control voltage. Figure 10 is a plot of the gain error of the cascaded stages versus the control voltages.

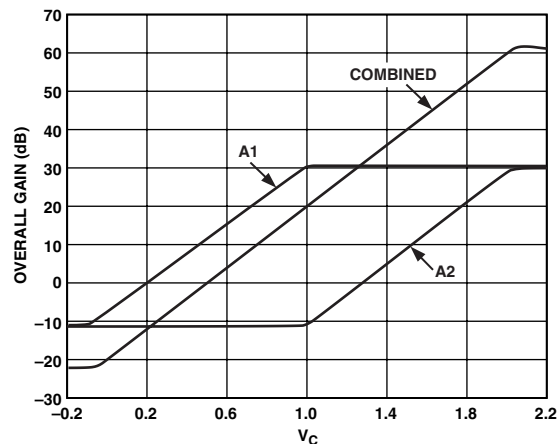

Figure 8. Plot of Separate and Overall Gains in Sequential Control

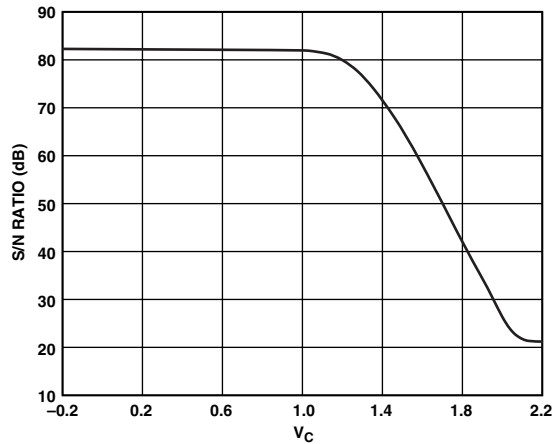

Figure 9. SNR for Cascaded Stages—Sequential Control

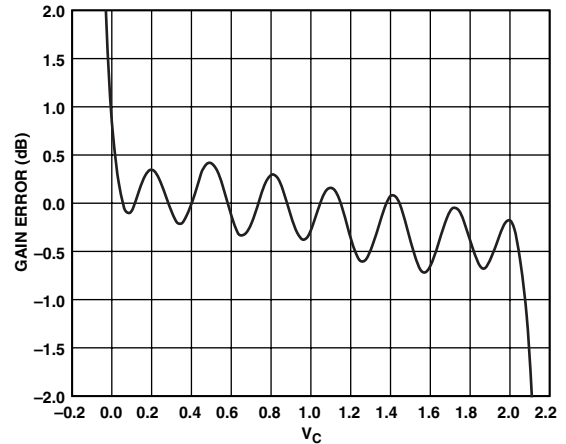

Figure 11. Gain Error for Cascaded Stages—Parallel Control

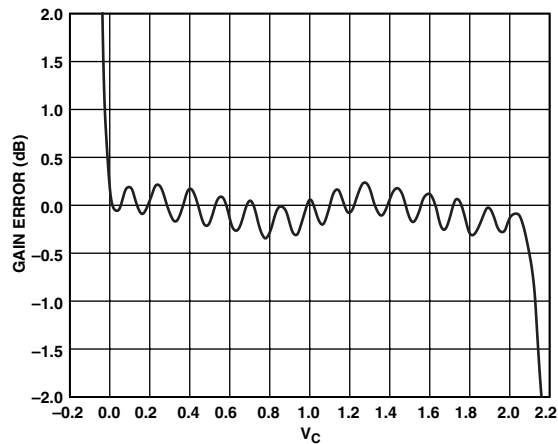

Figure 10. Gain Error for Cascaded Stages—Sequential Control

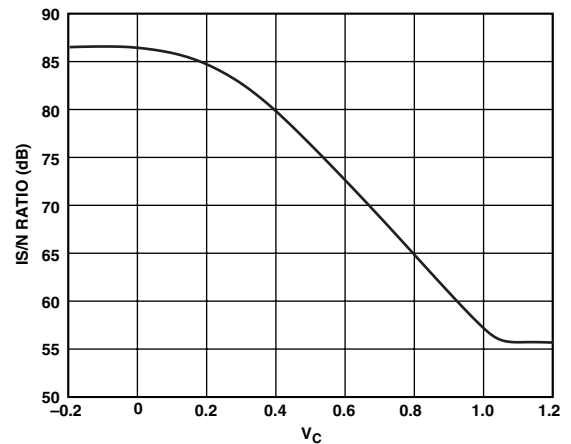

Figure 12. ISNR for Cascaded Stages—Parallel Control

Parallel Mode (Simplest Gain-Control Interface)

In this mode, the gain-control of voltage is applied to both inputs in parallel—the GPOS pins of both A1 and A2 are connected to the control voltage and the GNEW inputs are grounded. The gain scaling is then doubled to 80 dB/V, requiring only a 1.00 V change for an 80 dB change of gain:

$$\text{Gain (dB)} = 80 V_G + G_O \quad (4)$$

where, as before, G_O depends on the range selected; for example, in the maximum bandwidth mode, G_O is +20 dB. Alternatively, the GNEG pins may be connected to an offset voltage of 0.500 V, in which case, G_O is -20 dB.

The amplitude of the gain ripple in this case is also doubled, as shown in Figure 11, while the instantaneous signal-to-noise ratio at the output of A2 now decreases linearly as the gain increased, as shown in Figure 12.

Low Gain Ripple Mode (Minimum Gain Error)

As can be seen from Figures 9 and 10, the error in the gain is periodic, that is, it shows a small ripple. (Note that there is also a variation in the *output offset voltage*, which is due to the gain interpolation, but this is not exact in amplitude.) By offsetting the gains of A1 and A2 by half the period of the ripple, that is, by 3 dB, the residual gain errors of the two amplifiers can be made to cancel. Figure 13 shows that much lower gain ripple when configured in this manner. Figure 14 plots the ISNR as a function of gain; it is very similar to that in the parallel mode.

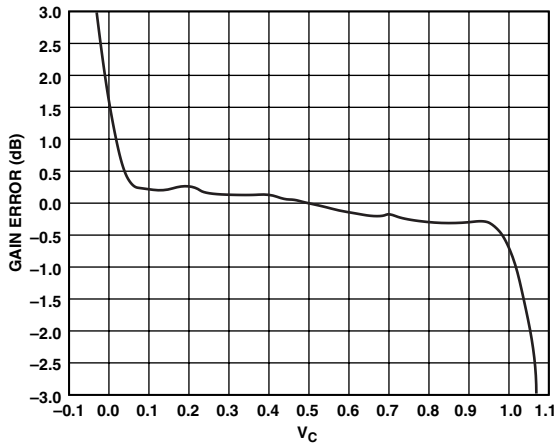

Figure 13. Gain Error for Cascaded Stages—Low Ripple Mode

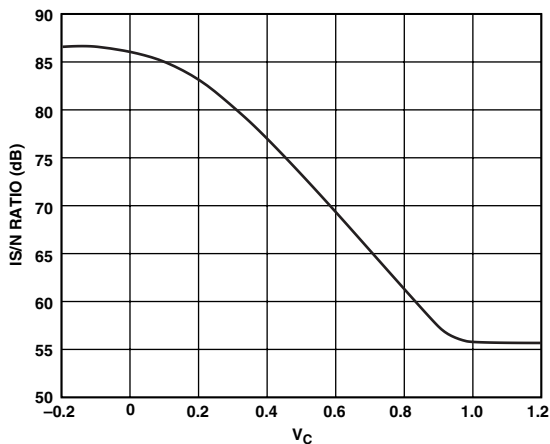

Figure 14. ISNR vs. Control Voltage—Low Ripple Mode

THEORY OF THE AD603

A Low Noise AGC Amplifier

Figure 15 shows the ease with which the AD603 can be connected as an AGC amplifier. The circuit illustrates many of the points previously discussed: It uses few parts, has linear-in-dB gain, operates from a single supply, uses two cascaded amplifiers in sequential gain mode for maximum S/N ratio, and an external resistor programs each amplifier's gain. It also uses a simple temperature-compensated detector.

The circuit operates from a single 10 V supply. Resistors R1, R2, R3, and R4 bias the common pins of A1 and A2 at 5 V. This pin is a low impedance point and must have a low impedance path to ground, here provided by the 100 μ F tantalum capacitors and the 0.1 μ F ceramic capacitors.

The cascaded amplifiers operate in sequential gain. Here, the offset voltage between the Pin 2 (GNEG) of A1 and A2 is 1.05 V (42.14 dB \times 25 mV/dB), provided by a voltage divider consisting of resistors R5, R6, and R7. Using standard values, the offset is not exact, but it is not critical for this application.

The gain of both A1 and A2 is programmed by resistors R13 and R14, respectively, to be about 42 dB; thus the maximum gain of the circuit is twice that, or 84 dB. The gain-control range can be shifted up by as much as 20 dB by appropriate choices of R13 and R14.

The circuit operates as follows. A1 and A2 are cascaded. Capacitor C1 and the 100 Ω of resistance at the input of A1 form a time constant of 10 μ s. C2 blocks the small dc offset voltage at the output of A1 (which might otherwise saturate A2 at its maximum gain) and introduces a high-pass corner at about 16 kHz, eliminating low frequency noise.

A half-wave detector is used, based on Q1 and R8. The current into capacitor C_{AV} is just the difference between the collector current of Q2 (biased to be 300 μ A at 300 K, 27°C) and the collector current of Q1, which increases with the amplitude of the

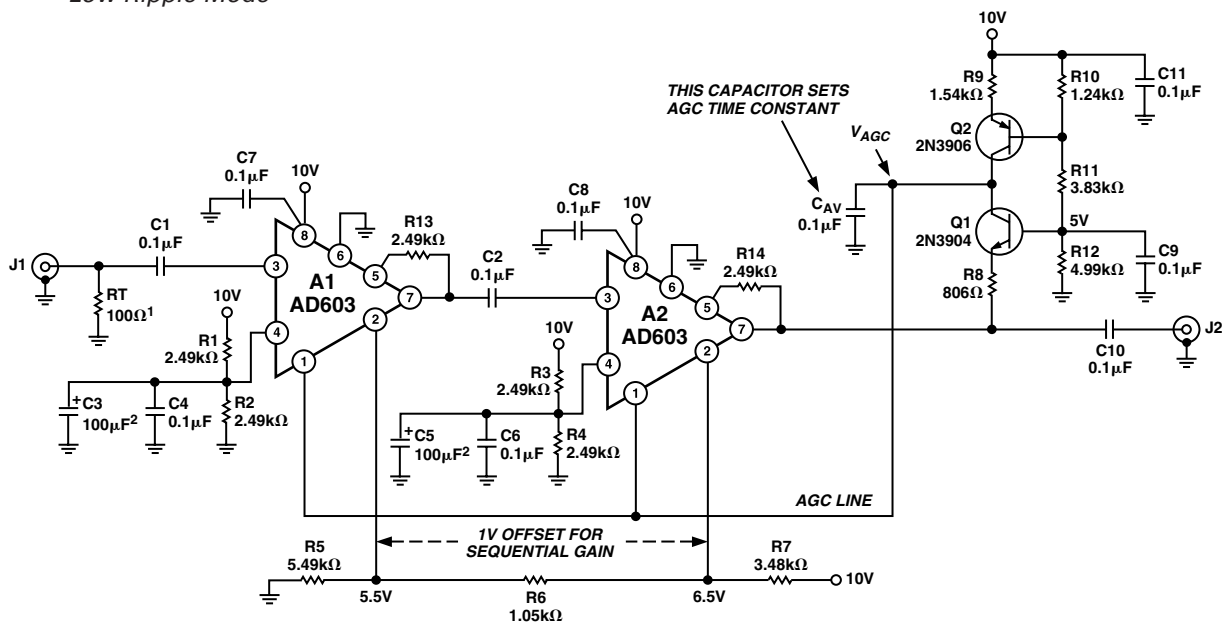

- NOTES
¹R_T PROVIDES A 50Ω INPUT IMPEDANCE
²C₃ AND C₅ ARE TANTALUM

Figure 15. A Low Noise AGC Amplifier

output signal. The automatic gain control voltage, V_{AGC} , is the time integral of this *error* current. In order for V_{AGC} (and thus the gain) to remain insensitive to short-term amplitude fluctuations in the output signal, the rectified current in Q1 must, on average, exactly balance the current in Q2. If the output of A2 is too small to do this, V_{AGC} will increase, causing the gain to increase, until Q1 conducts sufficiently.

Consider the case where R8 is zero and the output voltage V_{OUT} is a square wave at, say, 455 kHz, which is well above the corner frequency of the control loop.

During the time V_{OUT} is negative with respect to the base voltage of Q1, Q1 conducts; when V_{OUT} is positive, it is cut off. Since the average collector current of Q1 is forced to be 300 μA , and the square wave has a duty-cycle of 1:1, Q1's collector current when conducting must be 600 μA . With R8 omitted, the peak amplitude of V_{OUT} is forced to be just the V_{BE} of Q1 at 600 μA , typically about 700 mV, or 2 V_{BE} peak-to-peak. This voltage, therefore the amplitude at which the output stabilizes, has a strong negative temperature coefficient (TC), typically $-1.7 \text{ mV}/^\circ\text{C}$. Although this may not be troublesome in some applications, the correct value of R8 will render the output stable with temperature.

To understand this, first note that the current in Q2 is made to be proportional to absolute temperature (PTAT). For the moment, continue to assume that the signal is a square wave.

When Q1 is conducting, V_{OUT} is now the sum of V_{BE} and a voltage that is PTAT and which can be chosen to have an equal but opposite TC to that of the V_{BE} . This is actually nothing more than an application of the band gap voltage reference principle. When R8 is chosen such that the sum of the voltage across it and the V_{BE} of Q1 is close to the band gap voltage of about 1.2 V, V_{OUT} will be stable over a wide range of temperatures, provided, of course, that Q1 and Q2 share the same thermal environment.

Since the average emitter current is 600 μA during each half-cycle of the square wave, a resistor of 833 Ω would add a PTAT

voltage of 500 mV at 300 K, increasing by $1.66 \text{ mV}/^\circ\text{C}$. In practice, the optimum value will depend on the type of transistor used and, to a lesser extent, on the waveform for which the temperature stability is to be optimized; for the inexpensive 2N3904/2N3906 pair and sine wave signals, the recommended value is 806 Ω .

This resistor also serves to lower the peak current in Q1 when more typical signals (usually sinusoidal) are involved, and the 1.8 kHz LP filter it forms with C_{AV} helps to minimize distortion due to ripple in V_{AGC} . Note that the output amplitude under sine wave conditions will be higher than for a square wave, since the average value of the current for an ideal rectifier would be 0.637 times as large, causing the output amplitude to be 1.88 (= $1.2/0.637$) V, or 1.33 V rms. In practice, the somewhat nonideal rectifier results in the sine wave output being regulated to about 1.4 V rms, or 3.6 V p-p.

The bandwidth of the circuit exceeds 40 MHz. At 10.7 MHz, the AGC threshold is 100 μV (-67 dBm) and its maximum gain is 83 dB ($20 \log 1.4 \text{ V}/100 \mu\text{V}$). The circuit holds its output at 1.4 V rms for inputs as low as -67 dBm to $+15 \text{ dBm}$ (82 dB), where the input signal exceeds the AD603's maximum input rating. For a 30 dBm input at 10.7 MHz, the second harmonic is 34 dB down from the fundamental and the third harmonic is 35 dB down.

CAUTION

Careful component selection, circuit layout, power-supply decoupling, and shielding are needed to minimize the AD603's susceptibility to interference from signals such as those from radio and TV stations. In bench evaluation, we recommend placing all of the components into a shielded box and using feedthrough decoupling networks for the supply voltage. Circuit layout and construction are also critical, since stray capacitances and lead inductances can form resonant circuits and are a potential source of circuit peaking, oscillation, or both.

OUTLINE DIMENSIONS
8-Lead Ceramic Dual In-Line Package [CERDIP]
(Q-8)

Dimensions shown in inches and (millimeters)

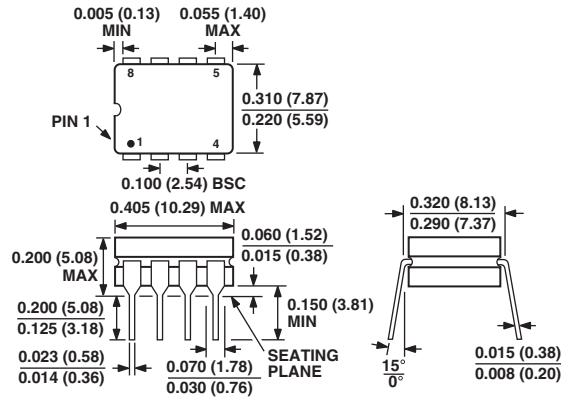

CONTROLLING DIMENSIONS ARE IN INCHES; MILLIMETERS DIMENSIONS (IN PARENTHESES) ARE ROUNDED-OFF INCH EQUIVALENTS FOR REFERENCE ONLY AND ARE NOT APPROPRIATE FOR USE IN DESIGN

8-Lead Standard Small Outline Package [SOIC]
Narrow Body
(R-8)

Dimensions shown in millimeters and (inches)

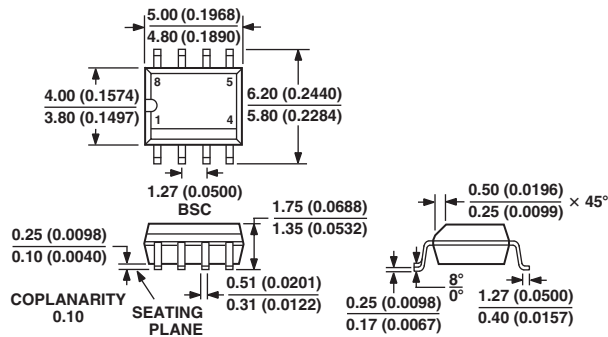

COMPLIANT TO JEDEC STANDARDS MS-012AA
 CONTROLLING DIMENSIONS ARE IN MILLIMETERS; INCH DIMENSIONS (IN PARENTHESES) ARE ROUNDED-OFF MILLIMETER EQUIVALENTS FOR REFERENCE ONLY AND ARE NOT APPROPRIATE FOR USE IN DESIGN

Revision History

<u>Location</u>	<u>Page</u>
8/03 Data Sheet changed from REV. D to REV. E.	
Updated Format.....	Universal
Changes to SPECIFICATIONS	2
Changes to TPCs 2, 3, 4	4
Changes to Sequential Mode (Optimal S/N Ratio) section	9
Change to Figure 8	10
Updated OUTLINE DIMENSIONS	14

